



PERFECT FILTRATION (Pty) Ltd
Lubrication Management, Oil Filtration and Electrical Services



TTI

Service • Quality • Innovation

Fuel Cleanliness Line

The #1 Trusted Fuel Filtration Elements, Coalescers,
Housings & Desiccant Breathers



The Importance of Proper Fuel Filtration

Not too long ago, diesel engines were simple, inefficient, and burned as much as 5,000 parts per million of high sulfur fuel. Today's high efficiency diesel engines require fuel to meet stringent emission standards and ISO cleanliness levels of 18/16/13, with a water content of less than 0.05%.

TTI's diesel fuel polishing technology exceeds manufacturer cleanliness standards by removing particulate, sludge, rust, and microbial contamination — regularly exceeding 2-mi-cron absolute filtration to ISO16889 and removing water to less than 75 PPM.

Engineered for reliability and performance, our coalescers excel at separating even the tiniest water droplets from fuel. This helps maintain the integrity of your systems, prevents corrosion and microbial growth, and minimizes maintenance costs. Whether you work in industrial settings, transportation fleets, or remote operations, TTI fuel coalescers ensure that your diesel and bulk fuel remains clean, dry, and ready for seamless operation, even in the most demanding environments.

TTI's Commitment to Excellence



Superior Performance

Our proprietary DuoGlass filter media and PowerGel silica gel provide up to 35% better protection from moisture and harmful contaminants to keep your fuel clean and dry in any conditions.



Fastest Lead Times

All TTI filter elements and desiccant breathers ship in 10 days or less rather than weeks or months, ensuring you always have access to preventative maintenance no matter your timeframe.



Longer Service Life

Industry-leading build quality, moisture retention, and dirt holding capacity ensure 20% longer service life, keeping your fuel and industrial systems running at peak efficiency for longer.



How We Protect Your Fuel from Moisture and Contamination

Our diesel fuel polishing technology exceeds manufacturer cleanliness standards by removing particulate, sludge, rust, and microbial contamination — regularly exceeding 2-micron absolute filtration to ISO16889 and removing water to less than 75 PPM.

TTI Fuel Coalescers

Engineered for reliability and performance, our coalescers excel at separating even the tiniest water droplets from fuel. This helps maintain the integrity of your systems, prevents corrosion and microbial growth, and minimizes maintenance costs.

Whether you work in industrial settings, transportation fleets, or remote operations, TTI fuel coalescers ensure that your diesel and bulk fuel remains clean, dry, and ready for seamless operation, even in the most demanding environments.

TTI Fuel Coalescer Housings

By reducing the presence of water and particulates, TTI fuel coalescers significantly minimize the wear and tear on critical components of your fuel system such as injectors and pumps. This leads to reduced maintenance requirements, extended service intervals, and enhanced operational reliability.

With an impressive 99% single-pass efficiency, the robust design of TTI's coalescer housings ensures that they are built to withstand even the toughest environments, making them the ideal choice for high-demand diesel fuel systems in industrial and commercial applications.

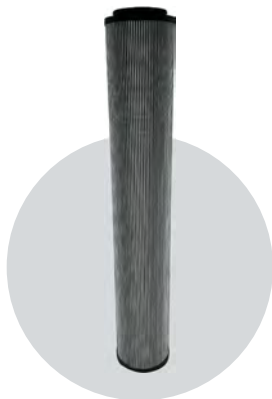

Filter Elements



Reservoir Desiccant Breathers



Diesel Fuel Coalescers



Filter Housings

TT207 Series

PERFORMANCE

- 50 PSID integral bypass
- 250°F (121°C) maximum operating temperature
- Collapse pressure dependent on housing

TTI's PowerGuard™ Filter line utilizes proprietary Dual Phase Microglass Media to provide world class filtration performance and longer service life for your equipment. Our built-in pre-filter layer ensures Beta 1000 efficiencies, reduces initial pressure drops, and provides superior dirt-holding capacity compared to our competitors.

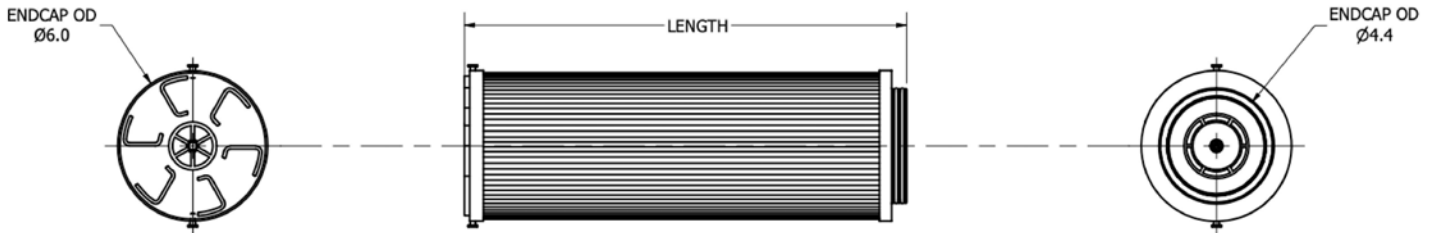

TTI PN	-	Length (inches)	-	Micron Rating (µm)	Media Type	Seal Type	
TT207		18 = 17.30		1	74*	(Omit) = Dual Phase Microglass <i>Standard option β1000, available in 1, 3, 6, 10, 25µm</i>	B = Buna
		36 = 35.60		3	149*	SD = Static Dissipative <i>Viton seals only, available in 1, 3, 6, 10, 25µm</i>	V = Viton
				6		WA = Water Absorptive <i>Available in 3, 6, 10, 25µm</i>	
				10		*W = Stainless Steel Wire Mesh <i>Only available in nominally rated 25, 74, 149µm</i>	
				25			

PART NUMBER EXAMPLE: TT207-36-3V = TT207 (36 length, 3 micron, viton seal type)

TT677 Coalescer Series

TTI's PowerGuard coalescing filter line leverages dual phase microglass media and world-class product design to ensure unparalleled filtration performance.

Manufactured in the USA and Germany, our proprietary DuoGlass technology provides Beta 1000 efficiencies with a built-in pre-filter layer to reduce initial pressure drops and extend the life of your filter elements.

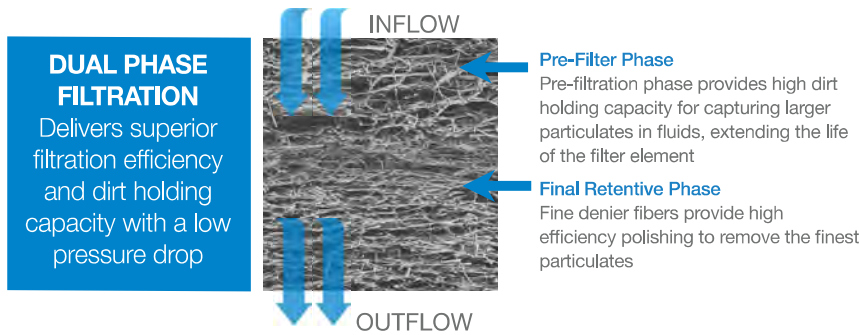
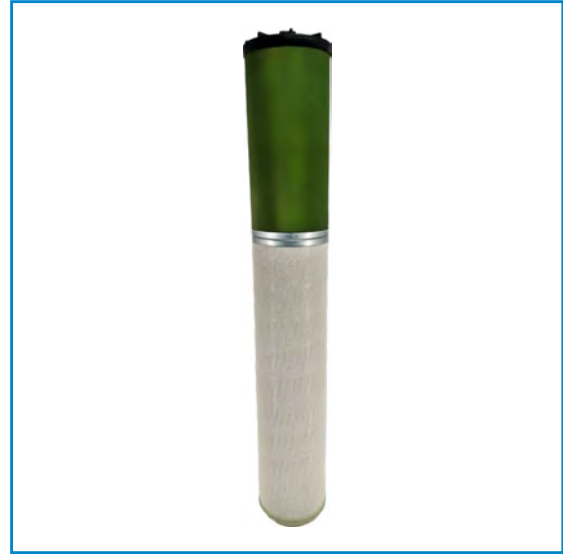

PERFORMANCE

- Diesel/water coalescing and separation
- Fiberglass coalescing material
- No cellulose used in construction
- Suggested change out every 4-6 months
- 25 PSID change out recommended
- Overall life is based on fuel cleanliness

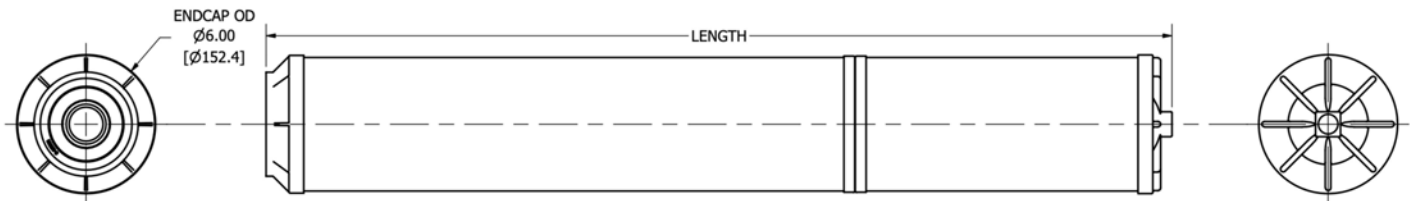

TTI PN	-	Length (inches)	-	Micron Rating (µm)	Media Type	Seal Type
TT677		39 = 39.3"		1	(Omit) = Dual Phase Microglass <small>Standard option β1000, available in 1, 3, 6, 10, 25µm</small>	B = Buna
				3	(Omit) = Fiberglass Coalescing Material	V = Viton
				6		
				10		
				25		

PART NUMBER EXAMPLE: TT677-39-25V = TT677 (39 inch length, 25 standard medias, Viton seal type)

PowerGuard™ Coalescing Filters

TT538 Series

TTI's PowerGuard coalescing filter line leverages dual phase microglass media and world-class product design to ensure unparalleled filtration performance.

Manufactured in the USA and Germany, our proprietary DuoGlass technology provides Beta 1000 efficiencies with a built-in pre-filter layer to reduce initial pressure drops and extend the life of your filter elements.

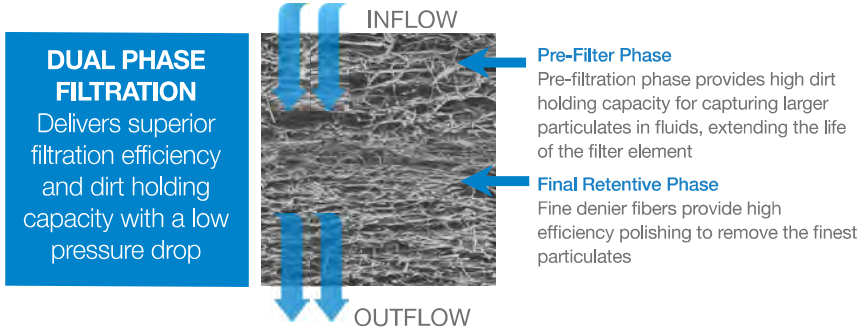

- PERFORMANCE**
- Diesel/water coalescing and separation
 - Fiberglass coalescing material
 - No cellulose used in construction
 - Suggested change out every 4-6 months
 - 25 PSID change out recommended
 - Overall life is based on fuel cleanliness

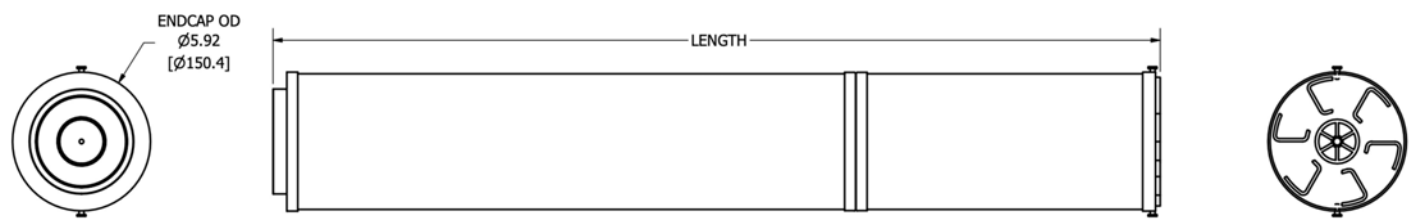

TTI PN	-	Length (inches)	-	Micron Rating (µm)	Media Type	Seal Type
TT538		38 = 38.0"		1	(Omit) = Dual Phase Microglass <small>Standard option β1000, available in 1, 3, 6, 10, 25µm</small>	B = Buna
				3	(Omit) = Fiberglass Coalescing Material	V = Viton
				6		
				10		
				25		

PART NUMBER EXAMPLE: TT538-38-10V = TT538 (38 inch length, 10 standard medias, Viton seal type)

TTHH-HC-4MS Housing

TTI's PowerGuard High Capacity Housing Line is the industry-leading choice for protecting your filter elements and extending the optimum performance of your machines.

Each TTHH-HC-4MS housing is constructed from 304 Stainless Steel and houses up to four industry-leading TT207 filter elements. Premium features include a solid mounting base, 290 PSI operating pressure, user-friendly closure flange, multi-directional gauge brackets, and sample/DP gauge ports.

Key Features

Maintenance friendly davit arm lid assembly with swing bolt closure flange.

Differential Pressure Gauge mounting bracket included standard. (consult TTI sales team to add DP Gage).

Bypass valve standard in each filter element guarantees consistent performance and optimal fluid cleanliness with the safety on an integral relief.

Square base: 20" with bolt holes to allow 5/8" [M16] anchor bolts for skid installation or mounting on pedestal (Consult TTI Sales Team to discuss custom pedestal base add-on).

2 - 1/4" NPT DP gage ports standard
 2 - 1/4" NPT Sampling ports standard
 1" NPT Low Point Dirty Drain port for fluid evacuation
 1/2" NPT Low Point Clean Drain port for fluid evacuation

Top Applications

- Pulp and Paper Mills
- Steel Mills
- Power Generation
- Bulk Fuel Particulate Filtration
- Flushing applications
- Large Reservoir Kidney Loop Filtration (Inline/Offline)



Performance Specifications

- 290 PSI working pressure - 2Mpa
- 750 GPM Flow Rate
- 304 Stainless Steel
- Hinged Lid for Ergonomic Filter Changeouts
- 32°-250° F (0°-120° C) Operating Temp Range
- Buna Seal Type Standard, FKM and EPR/EPDM available upon request

Fluid Compatibility

- Diesel Fuel and Fuel Oils
- Biodiesel up to B20
- Mineral Oils
- Synthetic Oils
- Skydrol™, Hyjet™, Fyrquel™, EcoSafe®
- AW Lubricants
- Water Glycol

Housing Dimensions

3" Raised Face Flange	Inlet/Outlet Opposite Side
Port-to-Port	23.50"
Port Height Centerline	10"
Overall Height	66.00"
Working Clearance	72"
Mounting Bolts Square	3" Raised Face Flange

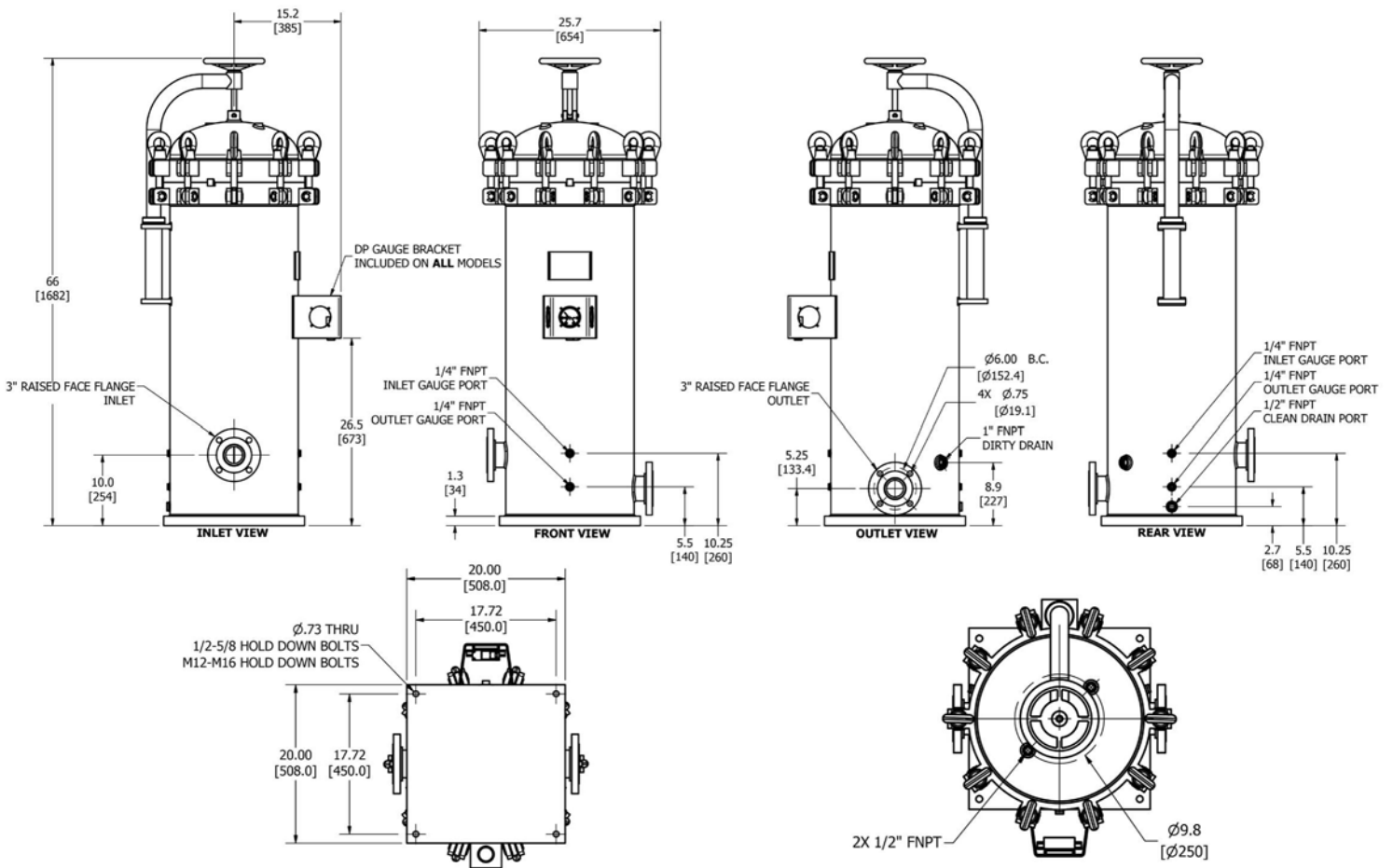

TTCH-538 Diesel Fuel Coalescer Housing

TTI's PowerGuard Diesel Fuel Coalescer Housing Line is the industry-leading choice for maximizing the efficiency and extending the life of your fuel delivery system.

Designed to remove water and particulate contaminants from diesel fuel with an impressive 99% single-pass efficiency, TTI fuel coalescers significantly reduces wear and tear on your system, helping to extend service intervals and enhance overall operational reliability.

Key Features

Diesel Fuel polishing and Coalescing - Flow rates up to 30 GPM single vessel

Universal bracket mount supports motor frame size 56C/143T/145T- provides location for customizable bracket installation by customer as well

Rigid base for skid mounting pattern is 7.75-inch square centerline with 5/8 inch diameter holes [M16] anchor bolts for skid installation or mounting on pedestal (Consult TTI Sales Team to discuss custom pedestal base add-on)

Fluid Compatibility

- Diesel Fuel and Fuel Oils
- Biodiesel up to B20

Top Applications

- Common Rail Diesel Fuel Polishing
- Drill Rig Fuel Polishing
- Mining Applications
- Merchant Marine Applications
- Bulk fuel storage/Bulk Fuel Delivery
- Large agriculture fuel conditioning
- Earthwork/Excavation
- Single pass or Multi-pass polishing
- Backup Power Generation



Performance Specifications

- 150 PSI working pressure
- Corrosion Resistant 304 Stainless Steel
- Hinged Lid for Ergonomic Filter Changeouts
- 30°-180° F (0°-82° C) Operating Temp Range
- Viton Seal Type Standard
- Integral post design ensures positive seal
- Swing bolt closure flange with integral tilt lid
- 2" Raised Face Flange inlet and outlet
- 1" Female NPT alternate inlet outlet ports
- 2 1/4" FNPT DP gage ports standard
- 2 1/4" FNPT Sampling ports standard
- 1/2" FNPT Low Point Water Leg Drain port
- 1/2" FNPT Low Point Clean Drain port
- 2 1/2" NPT ports for sight glass 10" centerline
- 2 1/2" BSPP (G thread) ports for instrumentation
- 1/4" FNPT vent port in lid

Vessel Dimensions

2" Raised Face Flange	Inlet/Outlet Opposite Side
Port-to-Port	16.93" (430.0 mm)
Port Height Centerline	Outlet 3.5" (88.9 mm) Low Point Staggered Inlet 7.375" (187.3 mm)
Overall Height	57.00" (1457 mm)
Working Clearance	110" (2794 mm)
Mounting Bolts Square	7.75" (196.9 mm)

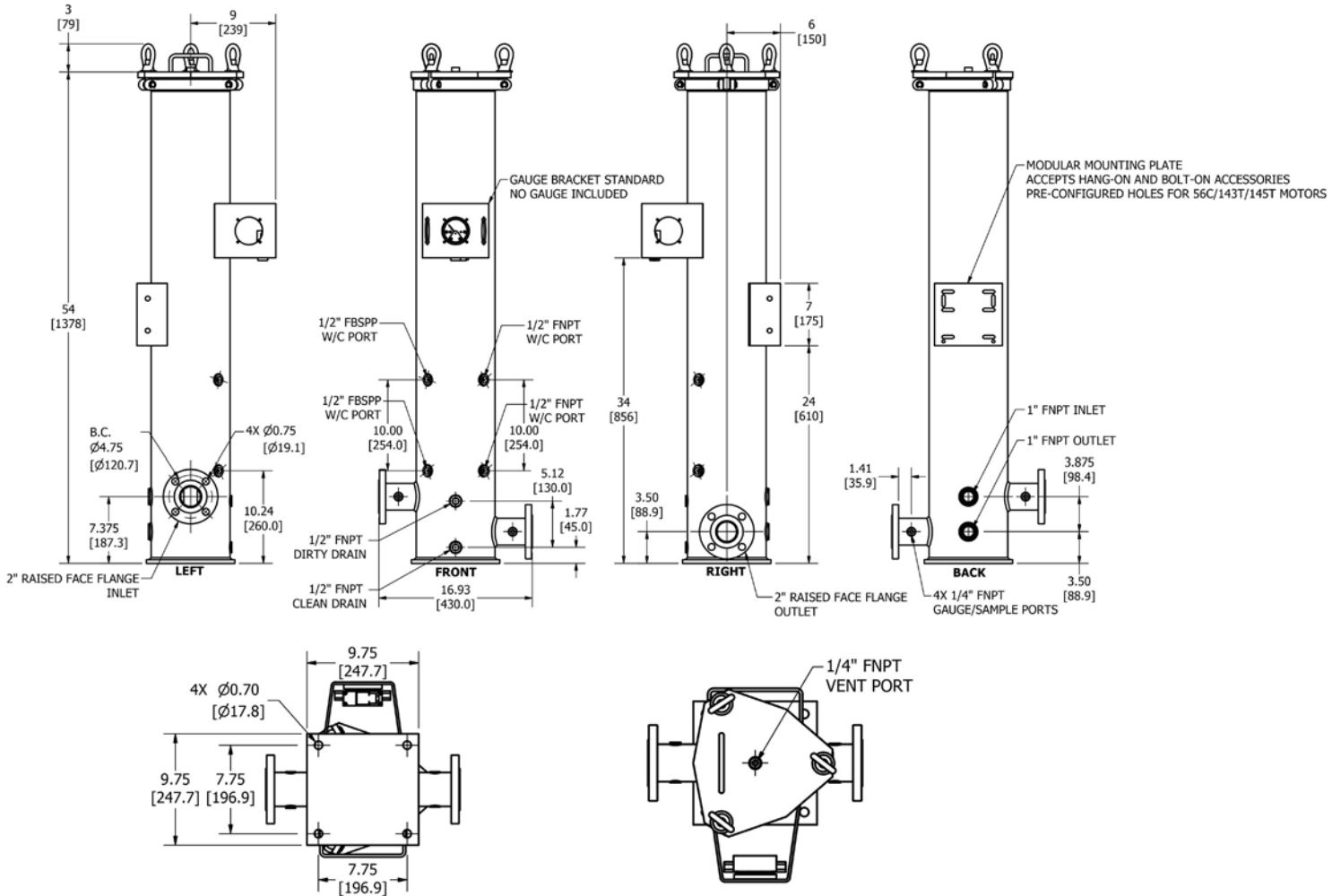

TT1350 Series

TTI's PowerGuard Filter Elements are produced using premium materials and are hand-checked by our dedicated team to ensure industry-leading performance.

Our proprietary Dual Phase Microglass media provides Beta 1000 efficiencies with a built-in pre-filter layer to extend filter life and reduce initial pressure drops.

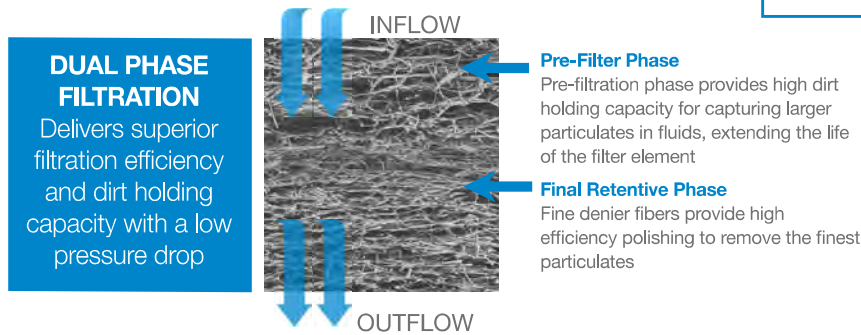

PERFORMANCE

- 150 PSID collapse pressure
- 50 PSID change out recommended
- 250°F (121°C) maximum operating temperature

Dimensions

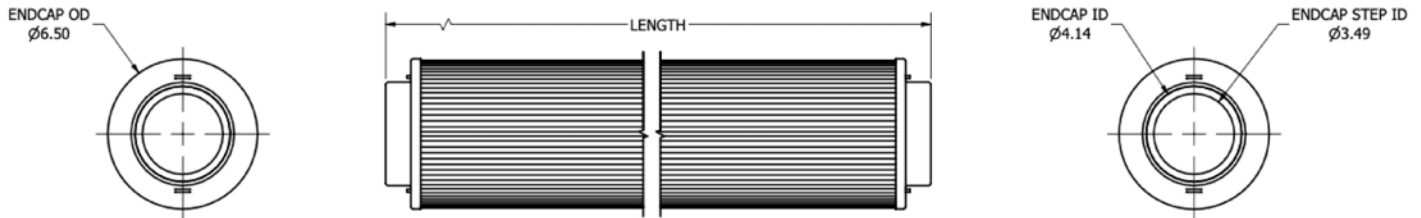

Part Number Builder

TTI PN	-	Length (inches)	-	Micron Rating (µm)	Media Type	Seal Type
TT1350		(omit) = 43.00"		1	(Omit) = Dual Phase Microglass <small>Standard option β1000, available in 1, 3, 6, 10, 25µm</small>	B = Buna
				3		V = Viton
				6		
				10		
				25		

PART NUMBER EXAMPLE: TT1350-3V = TT1350 (43 length, 3 micron, viton seal type)

TTC70 Coalescing Filter

TTI's PowerGuard Filter Elements are produced using premium materials and are hand-checked by our dedicated team to ensure industry-leading performance.

Our proprietary DuoGlass media provides Beta 1000 efficiencies with a built-in pre-filter layer to extend filter life and reduce initial pressure drops.



Disclaimer: Manufactured in Germany. Not for sale or distribution in the USA.

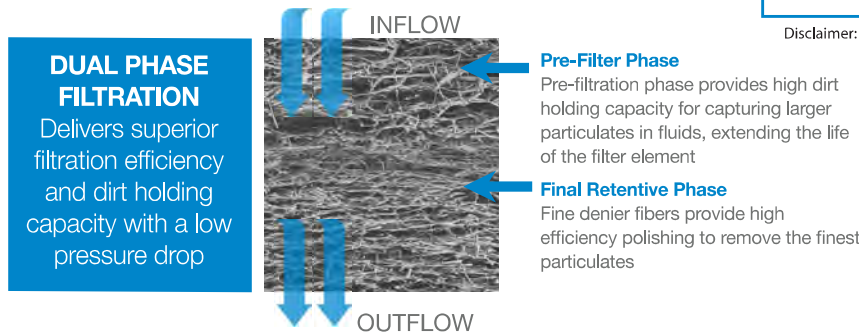

PERFORMANCE

- Diesel/water coalescing and separation
- 6-micron Beta 1000 filter rating
- 250°F (121°C) maximum operating temperature
- Fiberglass Coalescing Material

Dimensions

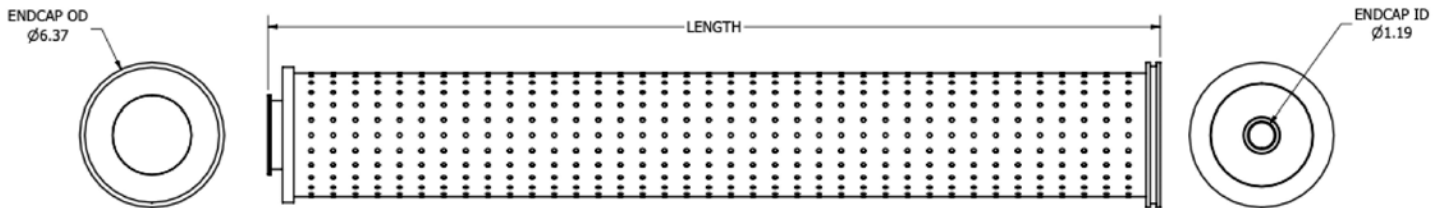

Part Number Builder

TTI PN	-	Length (inches)	-	Micron Rating (µm)	Media Type	Seal Type
TTC70		(Omit) = 39.8"		(Omit) = 6	(Omit) = Dual Phase Microglass <small>Standard option β1000, available in 1, 3, 6, 10, 25µm</small>	(Omit) = Viton

PART NUMBER EXAMPLE: TTC70 = TTC70 (39.8 length, 6 micron, viton seal type)

TT75S Spin-On Element

Spin-On Elements are used to clean hydraulic fluids and lubricants in pressurized fluid management systems.

In-line hydraulic filters are installed on the low-pressure return line side of a hydraulic system to clean fluid before it returns to the reservoir. Clean hydraulic fluid reduces contaminant buildup, controls operational & maintenance costs, and maximizes the service life of system components.

Spin-on canisters have an integrated pleated filter element. When the filter becomes clogged with contamination, the canister is simply unscrewed and replaced.

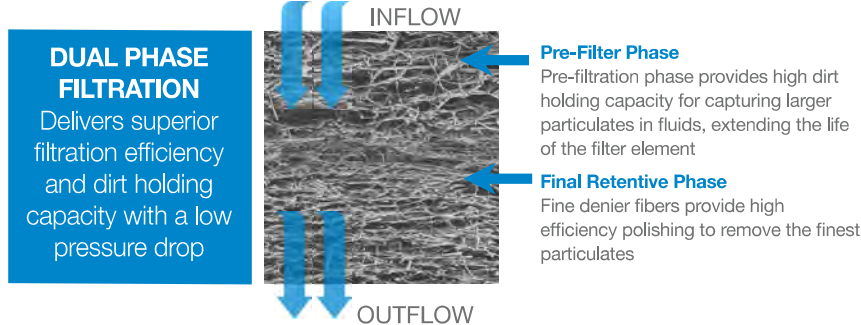

PERFORMANCE

- Steel Wire support layer for optimal strength
- Rugged 200 PSI maximum working pressure
- Available in all standard micron ratings and a water-absorptive grade

Part Number Builder

TTI PN	-	Length (inches)	-	Micron Rating (µm)	Media Type	Seal Type
TT75S		4		1	(Omit) = Dual Phase Microglass <small>Standard option β1000, available in 1, 3, 6, 10, 25µm</small>	B = Buna
		8		3		V = Viton
				6		
				10		
				25/25CWA*		

PART NUMBER EXAMPLE: TT75S-4-3V = TT75S (4 length, 3 micron, viton seal type)

Titan SmartFlow™ Model

The SmartFlow adapter allows for outflow of air prior to entering the breather. This protects the breather from oil mist and system humidity, resulting in longer breather life.

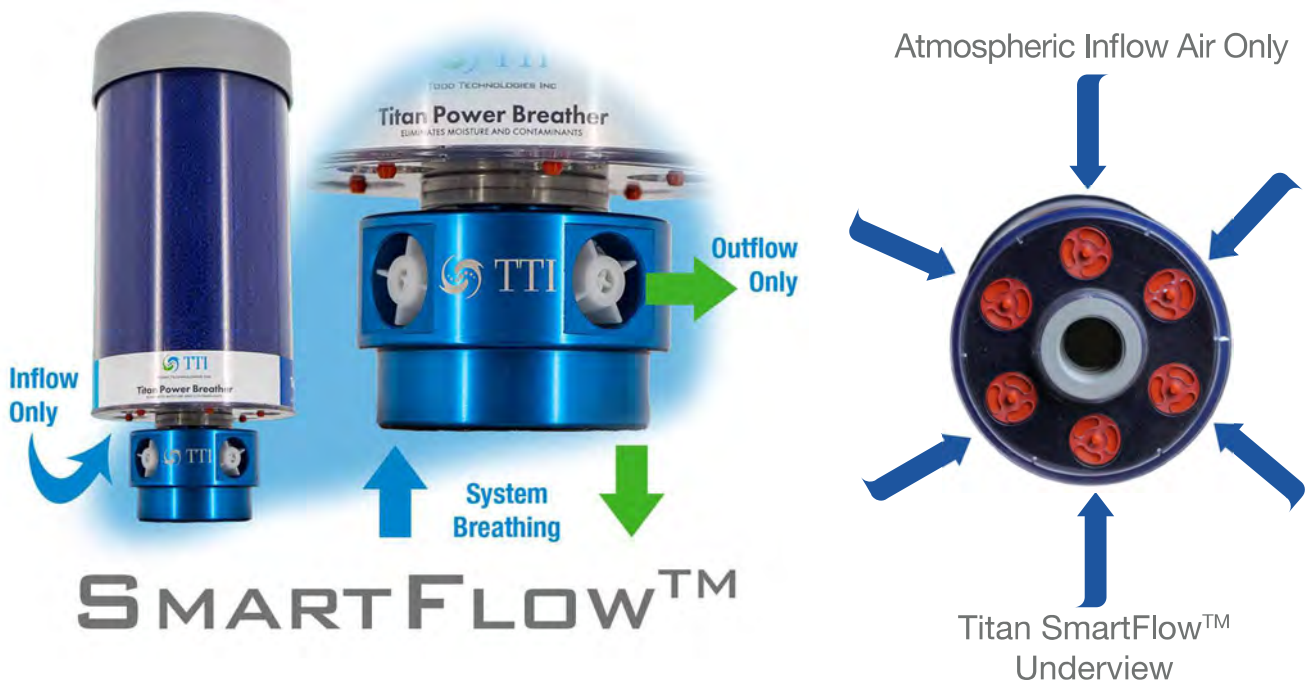

* Titan SmartFlow PowerBreathers (Titan-XXXX-SF) consist of all check valves positioned inward to exclusively inhale from the atmosphere, therefore must be used with the Titan-SF-A1 (1" FNPT) or Titan-SF-A2 (2" FNPT) SmartFlow Adapters to exhale all air out of the system.

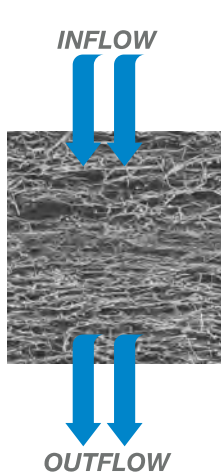

Superior Filtration

Delivers superior filtration efficiency, dirt holding capacity and low pressure drop.

1 Micron Retentive Layer
Fine denier fibers provide high-efficiency polishing to remove the finest particulate.

3-5 Micron Particulate Capture Layer
Pre-filtration Dual Phase Microglass layer provides high-capacity capture of bulk airborne particulate.

Dimensions

Standard Models	Europe	Connection	Height	Width	Max Airflow at 1psid	Max Moisture Retention
Titan-600	Titan-600E	1" Sure-Fit (FNPT, FBSPP, FNPSM)	4.4"	5.7"	27 cfm / 765 lpm	272 ml / 9.2 fl oz
Titan-1100	Titan-1100E	1" Sure-Fit (FNPT, FBSPP, FNPSM)	6.5"	5.7"	26 cfm / 736 lpm	500 ml / 16.9 fl oz
Titan-1600	Titan-1600E	1" Sure-Fit (FNPT, FBSPP, FNPSM)	8.6"	5.7"	25 cfm / 708 lpm	728 ml / 24.6 fl oz
Titan-2100	Titan-2100E	1" Sure-Fit (FNPT, FBSPP, FNPSM)	10.7"	5.7"	24 cfm / 680 lpm	958 ml / 32.4 fl oz

SmartFlow Models	Europe	Connection	Height	Width	Max Airflow at 1psid	Max Moisture Retention
Titan-600-SF	Titan-600E-SF	1" Sure-Fit (FNPT, FBSPP, FNPSM)	4.4"	5.7"	30 cfm / 845 lpm	272 ml / 9.2 fl oz
Titan-1100-SF	Titan-1100E-SF	1" Sure-Fit (FNPT, FBSPP, FNPSM)	6.5"	5.7"	29 cfm / 821 lpm	500 ml / 16.9 fl oz
Titan-1600-SF	Titan-1600E-SF	1" Sure-Fit (FNPT, FBSPP, FNPSM)	8.6"	5.7"	28 cfm / 793 lpm	728 ml / 24.6 fl oz
Titan-2100-SF	Titan-2100E-SF	1" Sure-Fit (FNPT, FBSPP, FNPSM)	10.7"	5.7"	26 cfm / 736 lpm	958 ml / 32.4 fl oz

SmartFlow Adapters

Titan-SF-A1	1" Female NPT
Titan-SF-A2	2" Female NPT

*Titan SmartFlow™ PowerBreather™s (Titan-XXXX-SF consists of all check valves positioned inward to exclusively inhale from the atmosphere, therefore must be used with the Titan-SF-A1 (1" FNPT) or Titan-SF-A2 (2" FNPT) SmartFlow™ Adapters to exhale all air out of the system.

**Titan-Adapter-SF adds 2.2 inches of height to SF model Titan PowerBreather™s.

No Check Valve Models	Europe	Connection	Height	Width	Max Airflow at 1psid	Max Moisture Retention
Titan-600-NC	Titan-600E-NC	1" Sure-Fit (FNPT, FBSPP, FNPSM)	4.4"	5.7"	39 cfm / 1104 lpm	272 ml / 9.2 fl oz
Titan-1100-NC	Titan-1100E-NC	1" Sure-Fit (FNPT, FBSPP, FNPSM)	6.5"	5.7"	36 cfm / 1019 lpm	500 ml / 16.9 fl oz
Titan-1600-NC	Titan-1600E-NC	1" Sure-Fit (FNPT, FBSPP, FNPSM)	8.6"	5.7"	35 cfm / 991 lpm	728 ml / 24.6 fl oz
Titan-2100-NC	Titan-2100E-NC	1" Sure-Fit (FNPT, FBSPP, FNPSM)	10.7"	5.7"	32 cfm / 906 lpm	958 ml / 32.4 fl oz

Standard Materials On All Models

Body
ABS, Nylon,
Polypropylene, Buna-N

Moisture Absorbing Media
Blue Silica Gel,
Orange Gel for Europe

Dual Phase Microglass Media

Filter Efficiency
1 Micron Absolute

Operating Temperatures
-20 F to 200 F,
-29 C to 93 C





TTI

Service • Quality • Innovation

Rebuildable Stainless Steel PowerBreather™

Protects lubricants and equipment from moisture and particulate intrusion.

Extends service cycles and equipment life in high-flow applications.



304 SS Construction

Priced below competitors carbon steel units. TTI believes carbon steel should be eliminated in high humidity environments.

20% More Microglass Media

Equating to more dirt holding capacity.

20% More Moisture Holding

Capacity for the PowerBreather Gel compared to competitors and proven in head-to-head trials.

Fully Compatible

With DES-CASE rebuildable breathers.

The TTI Rebuildable PowerBreather™ offers the ability to remove both particulate and moisture in high-flow and extreme humidity environments.

While in service, the PowerBreather™ eliminates moisture and particulate intrusion into the system. During shutdown, the PowerGel silica gel attracts moisture by actively drying the system.

Rebuild Kit

Replacement Filter Cartridge

Pleated microglass filter cartridge captures airborne contaminants to 1 micron absolute.

Desiccant Bag Filter

Polypropylene bag has handles for easy removal and replacement.

Sight Glass Indicator

Silica gel changes color from blue to pink when the unit requires rebuilding.

Note: Rebuild kit also includes lid gasket, sight glass gasket and oil dispersing foam pad.

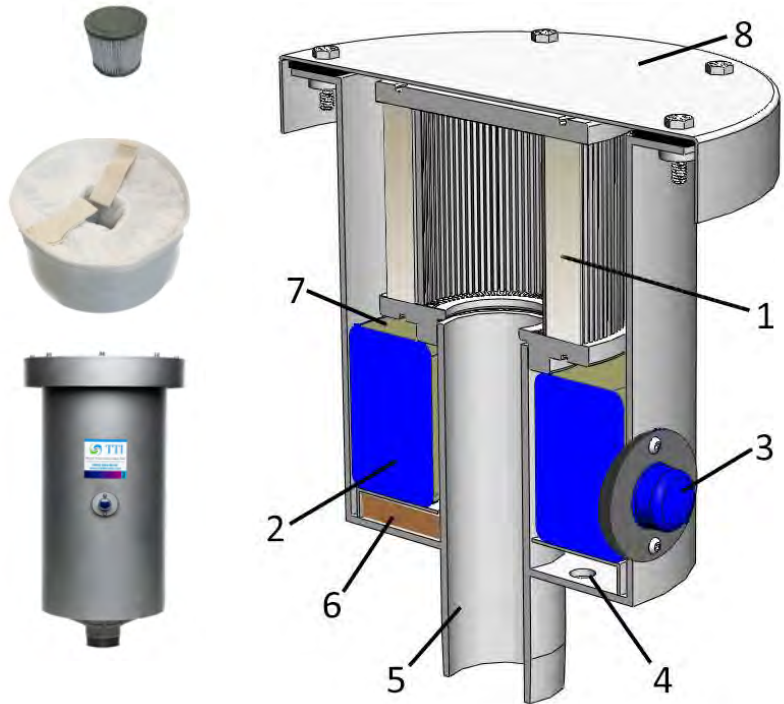

Rebuildable PowerBreather™ Components

1-Pleated Filter Cartridge

Pleated microglass filter cartridge captures airborne contaminants to 1 micron absolute.

2-Desiccant

PowerGel strips moisture from incoming air.

3-Sight Glass Indicator

PowerGel changes color from blue to pink when the unit requires rebuilding.

4-Air Vents

Removable stickers keep breather inactive until installation.

5-Integrated Standpipe

Open-flow construction provides negligible

resistance to air flow and allows oil mist to coalesce and drain back into the reservoir.

6-Foam Pad

Polymeric foam filter pad captures large particulate, attracts and absorbs oil, and disperses incoming air evenly across the filter cartridge and desiccant media.

7-Easy to Replace Desiccant Bag

Polypropylene bag has handles for easy removal.

8-Rugged Housing

Robust 304 SS construction eliminates chance of corrosion in high humidity environments.

Dimensions

Model	Height inches/cm	Width inches/cm	Approx. Dry Weight lbs/kg	Amount of Desiccant lbs/kg	Max Absorption Capacity gal/L	Max. Air Flow Rate cfm	Operating Temperature	Connect Size
TT-RS-3	11.5/29.2	10.1/25.7	16/7.26	3/1.36	0.14/0.54	85 @ 0.5psid	-20-220°F/ -29-104°C	2"
TT-RS-5	13.75/34.9	10.1/25.7	20/9.07	5/2.27	0.24/0.9	85 @ 0.5psid	-20-220°F/ -29-104°C	2"
TT-RS-9	18.25/45.4	10.1/25.7	27/12.25	9/4.08	0.43/1.62	80 @ 0.5psid	-20-220°F/ -29-104°C	2"
TT-RS-15	19.25/48.9	15.5/39.4	49/22.23	15/6.80	0.71/2.7	205 @ 0.5psid	-20-220°F/ -29-104°C	3"
TT-RS-25	22.5/57.1	15.5/39.4	64/29.03	25/11.34	1.19/4.5	140 @ 0.5psid	-20-220°F/ -29-104°C	3"
TT-RS-50	31.25/79.4	15.5/39.4	100/45.36	50/22.68	2.38/9	115 @ 0.5psid	-20-220°F/ -29-104°C	3"
TT-RS-75	39.75/101	15.5/39.4	144/65.32	75/34.02	3.57/13.5	80 @ 0.5psid	-20-220°F/ -29-104°C	3"

All models are available in EU with orange gel and follow the same dimensions. EU codes are the following: TTE-RS-3 | TTE-RS-5 | TTE-RS-9 | TTE-RS-15 | TTE-RS-25 | TTE-RS-50 | TTE-RS-75

Features

- 304 Stainless Steel housing
- Easy to replace desiccant bags remove moisture from incoming air
- Pleated filter removes particles to 1-micron absolute
- Eliminates rust forming condensation
- Prevents water contaminated fluid and sludge deposits
- Reduces wear and tear on equipment prolonging life

Materials

Housing:

304 Stainless Steel

Moisture Absorbing Media:

Silica Gel

Filter Media:

Microglass, Polyurethane

Gasket/Seal:

Buna-N

Rebuild Parts & Accessories

(TTI Rebuild Kits can be used in DES-CASE Rebuildable PowerBreather™s)

Model	Description
TT-RS*-RK	Rebuildable Stainless Steel Breather Kits
TT-RS*-F1	Rebuildable Stainless Steel Breather Microglass Filter Cartridge
TT-RS*-D1	Rebuildable Stainless Steel Desiccant Bag
TT-RS*-SG1	Rebuildable Stainless Steel Breather Sight Glass
TT-RS*-P1	Rebuildable Stainless Steel Breather Foam Pad Insert
TT-RS*-G1	Rebuildable Stainless Steel Breather Gasket Seals

NOTE: For part codes containing an (*), substitute the appropriate RS model number. (Example: the part code for a rebuildable stainless steel breather kit for the TT-RS-75 would be TT-RS-75-RK.).

All model kits are available in EU, for the model number add "E" after TT. Example: the part code for a EU rebuildable stainless steel breather kit for the TT-RS-75-RK would be TTE-RS-75-RK.

TTI recommends use of a pressure relief valve on any tank or storage system.

TTI Team Members Are Always Available to Help



Derek Kula

**VP of Business Development: MLT 1
US Office**

Cell: +1 949 335 2438

Email: derek@toddtechinc.com



Dustin Flynn

**Account Manager, US East: MLT 1
US Office**

Cell: +1 949 563 3003

Email: dustin@toddtechinc.com



Christian Stapen

**Account Manager, US West: MLT 1
US Office**

Cell: +1 303 638 7939

Email: christian@toddtechinc.com



Hans J Rauch

VP of Global Sales & Marketing

Cell: +49 (0)160 9114 5292

Email: hans-j.rauch@toddtechinc.com



Ellina Buchen

**Business Development Manager, Europe
EU Office**

Cell: +49 (0)175 850 5501

Email: ellina@toddtechinc.com

